

Handheld Multi CO₂ Detector



- CO₂
- Temp.
- RH
- Real Time
- Thermal Image (option)



ZG5

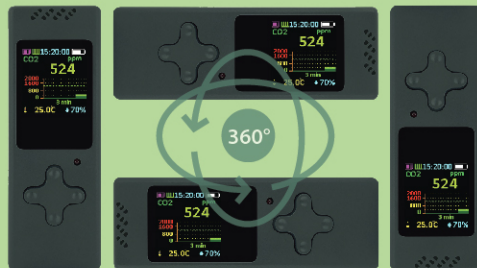

360° automatic LCD rotation

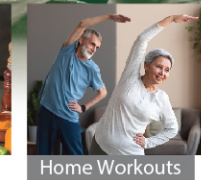
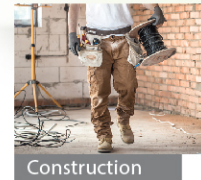

- Dual beam NDIR technology is used to measure CO₂ up to 9,999ppm.
- 360° automatic LCD rotation for easy reading.
- Audible alarm and CO₂ indicator record for 24 hours.
- Clearly display with color TFT LCD.
- Detection of CO₂, RH and temperature, THi and SEi.
- Visible 32*32 thermal image sensor(option).
- Support Li-ion 18650 battery for more than 20 hours.

IAQ CO₂ concentration status

Beeping Alarm

- Only once
- Every 10secs
- Every 5mins

CO₂ >1,400ppm, you will hear 3 beep sounds.
 CO₂ >4,000ppm, you will hear 4 beep sounds.
 CO₂ >5,000ppm, you will hear 5 beep sounds.

The index of Indoor Air Quality : THi and SEi
 THi : Temperature- Humidity Index
 SEi : IAQ air quality + THi
 (Environmental Comfort Index)

Emotion Icons Display

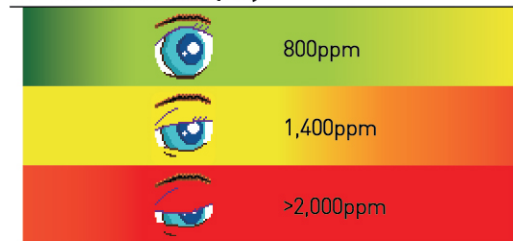

The color gradually changes with CO₂ concentration



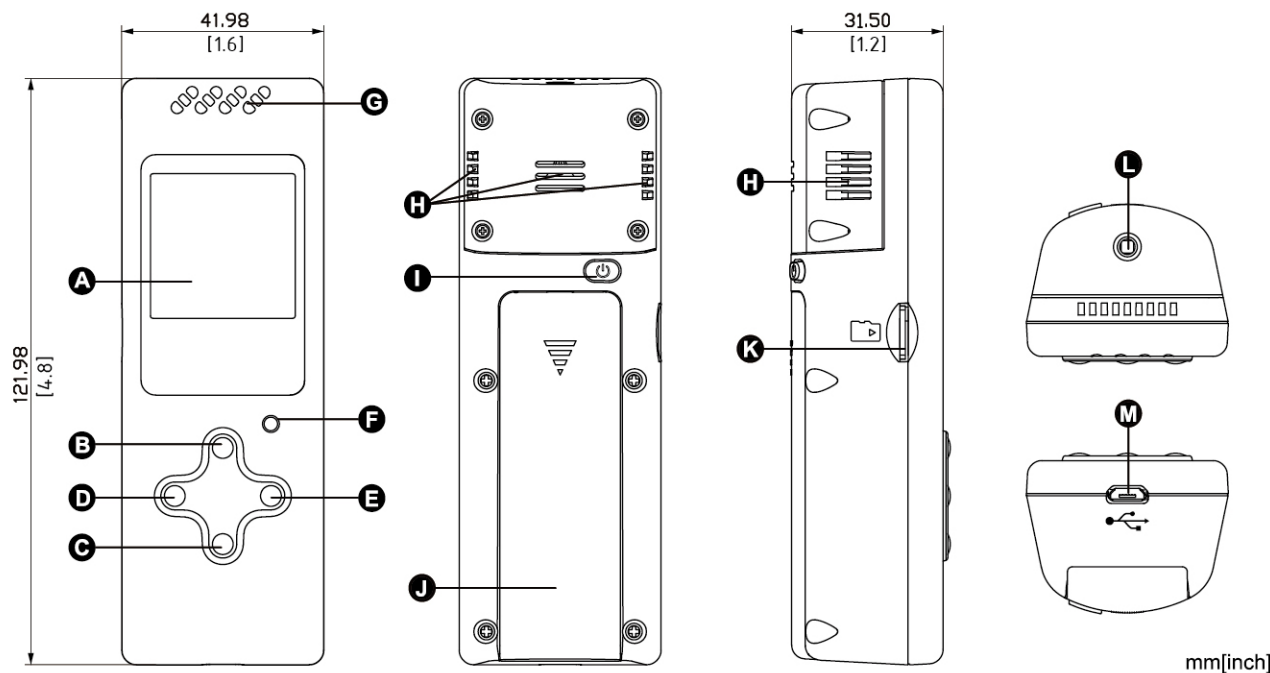

- A** LCD
- B** Up Key
- C** Down Key
- D** Mode Key
- E** Enter Key
- F** Charging LED Indicator
- G** Temperature and Humidity Sensor
- H** Ventilation Slots
- I** Power Key
- J** Battery Cover
- K** Micro SD Card Slot
- L** Thermal Image Sensor(Optional)
- M** Micro USB Slot

mm[inch]

Specifications

CO₂ Specification

Measurement Range	0~9,999 ppm
Accuracy	±(50 ppm+3% of reading)
Resolution	1 ppm

Temperature Specification

Measurement Range	0°C~50°C (32°F~122°F)
Accuracy	±1°C (±2°F)
Resolution	0.01°C (0.01°F)

RH Specification

Measurement Range	0%~100% RH
Accuracy	±5% , sensor drift is 1% per year
Resolution	0.01%

Atmospheric Pressure Specification

Measurement Range	50Kpa~110Kpa
Accuracy	±0.4kpa
Resolution	0.1mmHg
Thermal Image Measurement Range and Resolution(Optional)	0°C~80°C (32°F~176°F); visible 32*32

Operating Conditions

Temperature	0°C~50°C (32°F~122°F)
Humidity	0~95% RH, non-condensing
Interface	Micro USB

Battery Condition

Power Supply	Rechargeable Battery (not included) Li-ion 3.7V Unprotected Button top 18650 battery*1pcs (L65~67mm, Ø18~19mm)(Battery Life: more than 20 hours)
Adapter	5V±5% >1A, 100~240VAC, 50/60Hz
Micro SD RAM	Support micro SD card up to 32G. (Recommend to use the attached 16G micro SD card)

Storage Condition

Temperature	-20°C~60°C (-4°F~140°F)
--------------------	-------------------------

(Specifications are subject to change without notice)

LCD Display

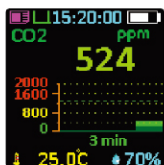

Main Screen



Time Display

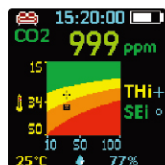

THI and SEI Display

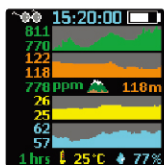

All Sensors Display



Set Menu



User Manual

Rotated Screen



360° automatic LCD rotation